

Q-POWER 10

A



CLIP



HOUT



SIGNAL



ON



B



CLIP



HOUT



SIGNAL



ON



C



CLIP



HOUT



SIGNAL



ON



D



CLIP



HOUT



SIGNAL



ON



CAMCO

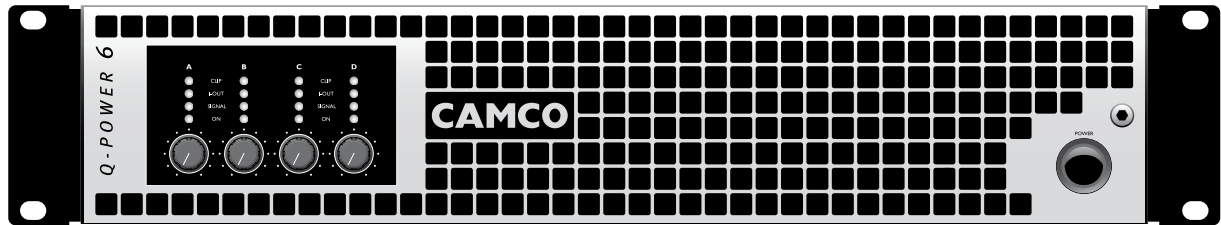
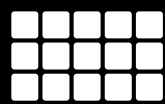

**INFORMATION FOR USE FOR MODELS
Q-POWER 4, Q-POWER 6 and Q-POWER 10**

QUM_GB_2008-2009-R4_06-2009

© Copyright 2008 by **CAMCO** Produktions- und Vertriebs-GmbH
für Beschallungs- und Beleuchtungsanlagen
Fischpicke 5, D-57482 Wenden, Germany
Telephone +49 (0) 2762 408-0

Q - POWER SERIES



IMPORTANT SAFETY INSTRUCTIONS

- 1) Read the information for use (user manual).
- 2) Please keep this user manual in a safe place during the lifetime of the amplifier. The user manual forms an integral part of the amplifier. Reselling of the amplifier is only possible if the user manual is available. Any changes made to the amplifier have to be documented in writing and passed on to the buyer in the event of resale.
- 3) Heed all warnings.
- 4) Follow all instructions.
- 5) Do not expose this device to rain or moisture. Do not use this amplifier near water (for example, swimming pools and fountains). Do not place any objects containing liquids, such as bottles or glasses, on the top of the unit. Do not splash liquids on the unit. IP-20 equipment. No Protection against splashing water.
- 6) Clean only with dry cloth.
- 7) Do not block any ventilation openings. Install in accordance with the user manual.
- 8) Do not install near any heat sources such as radiators, heat registers, stoves or other apparatuses that produce heat.
- 9) Protect the power cord from being walked on, pinched or damaged in any other way. Pay particular attention to plugs and the point where they exit from the amplifier.

10) The amplifier may only be used in accordance with the information provided in the user manual. Before and during the usage of the amplifier please ensure that all recommendations, especially the safety recommendations as detailed in the user manual, are adhered to.

The **Q-POWER** Amplifier is designed for the amplification of pulsed audio signals and the amplifier should only be connected to speakers with an average impedance as indicated.



11) Do not place this amplifier on an unstable cart, stand, tripod, bracket or table. The device may fall, causing serious injury and serious damage to the device itself.

12) The amplifier can only be disconnected from the power supply by removing the plug which must be freely accessible at all times. Unplug this amplifier during lightning storms or when unused for long periods of time.

13) Refer all servicing to qualified service personnel.
Servicing is required when

- the power-supply cord or plug has been damaged,
- liquid has been spilled or objects have fallen into the amplifier,
- the amplifier has been exposed to rain or moisture,
- the amplifier has been dropped or suffered damage in any other way,
- the amplifier exhibits a distinct change from its normal function or performance.



CAUTION
RISK OF ELECTRIC SHOCK
DO NOT OPEN



CAUTION – HIGH VOLTAGE HAZARDS
EXIST WITHIN THIS PRODUCT.
REFER ALL SERVICING TO
AUTHORISED PERSONNEL.



THE LIGHTNING FLASH WITH ARROW HEAD SYMBOL IS INTENDED TO
ALERT THE USER TO THE PRESENCE OF UNINSULATED DANGEROUS
VOLTAGE WITHIN THE PRODUCT'S ENCLOSURE.



THE EXCLAMATION MARK IS INTENDED TO ALERT THE USER
TO IMPORTANT INSTRUCTIONS ALSO FOR MAINTENANCE IN THE
LITERATURE ACCOMPANYING THE AMPLIFIER.



THE LIGHTNING FLASH WITH ARROW HEAD SYMBOL ALERTS
THE USER TO DANGEROUSLY HIGH VOLTAGE AT THE SPEAKON
CONNECTORS THAT COULD POTENTIALLY BE LIFE THREATENING.

CAUTION – RISK OF ELECTRIC SHOCK – DO NOT OPEN.

WARNING – TO PREVENT FIRE OR SHOCK HAZARD, DO NOT EXPOSE THIS
AMPLIFIER TO RAIN OR MOISTURE.



THE AMPLIFIER MAY ONLY BE CONNECTED
TO A SOCKET WITH A PROTECTIVE EARTH CONDUCTOR.

1. Read the information for use (user manual)

When shipping the **Q-POWER** amplifier always use the original shipping carton and packing materials. For maximum protection repack the unit as it was originally packed at the factory.

2. Environments

Use this amplifier only in E1,E2,E3,E4 or E5 environments according to EN55103-2 "Electromagnetic compatibility – Product family standard for audio, video and audio-visual and entertainment lighting control apparatus for professional use – Part 2: Immunity"

3. Ventilation

Slots and openings in the cabinet are provided for ventilation to ensure reliable operation of the amplifier and to protect it from overheating. These openings must not be blocked or covered. This amplifier should not be installed unless proper ventilation is provided or manufacturer's instructions have been adhered to.

4. Water and Moisture

Do not expose this device to rain or moisture. Do not use this amplifier near water (for example, swimming pools and fountains). Do not place any objects containing liquids, such as bottles or glasses, on the top of the unit. Do not splash liquids on the unit. IP-20 equipment. No Protection against splashing water.

5. Cleaning

Unplug this amplifier from the wall outlet before cleaning. Do not use liquid or aerosol cleaners.

6. Power-cord Protection

Power-supply cords should be routed so that they are not likely to be walked on or pinched by items placed upon them or against them, paying particular attention to cords and plugs and the point where they exit from the amplifier.



7. Lightning

For added protection of this amplifier during lightning storms or when it is left unattended and unused for long periods of time, unplug it from the wall outlet. This will prevent damage to the amplifier due to lightning and power-line surges. Disconnection from the mains power supply can only be achieved by removing the plug from the mains socket and by external disconnecting all poles from the mains.

8. Interference of external objects and/or liquids with the appliance

Never push objects of any kind into this amplifier through openings as they may touch dangerous voltage points or short out parts that could result in a fire or electric shock. Never spill liquid of any kind on the amplifier.

9. Accessories

Do not place this amplifier on an unstable cart, stand, tripod, bracket or table. The amplifier may fall, causing serious injury and serious damage to the product. Any mounting of the amplifier should follow the manufacturers instructions and should use a mounting accessory recommended by the manufacturer.

10. Connecting

When you connect the amplifier to other equipment turn off the power and unplug all of the equipment from the supply source. Failure to do so may cause an electric shock and serious personal injury. Read the user manual of the other equipment carefully and follow the instructions when making the connections.

11. Sound Volume

Reduce the volume to minimum before you turn on the amplifier to prevent sudden high levels of noise which may cause hearing or speaker damage.
(See also section 4.2.1 Volume control)

12. Damages that require service

Unplug this amplifier from the mains supply and refer to your dealer/distributor or other authorised repair workshop if any of the following situations occur:

- if liquid has been spilled or objects have fallen into the amplifier
- if the amplifier does not operate normally as described in the user manual, operate the controls only as described in the user manual
- if the amplifier has been dropped or damaged in any other way
- when the amplifier exhibits a distinct change from its normal function or performance

13. Servicing

Do not attempt to service this amplifier yourself. As opening or removing covers may expose you to dangerous voltage or other hazards, the amplifier may only be opened by qualified personnel. Please refer to your dealer/distributor.

14. Servicing and Replacement Parts

All service and repair work must be carried out by a **CAMCO** authorised dealer. When replacement parts are required, please ensure that the dealer/distributor only uses replacement parts specified by the manufacturer. The use of unauthorised replacement parts may result in injury and/or damage through fire or electric shock or other electricity-related hazards.

15. Safety Check

Upon completion of any service or repairs to this product, ask the dealer/distributor to perform safety checks to determine that the amplifier is in proper operating condition.

Recommendations on how to carry out the safety test can be found in DIN VDE 0701-1 "Maintenance, Modification and Test of Electronic Appliances".



EC Declaration of Conformity in accordance to EC Directives:
electro-magnetic compatibility (Council Directive 2004/108/EC);
low-voltage electrical equipment (Council Directive 73/23/EEC)

Manufacturer's Name:

CAMCO Produktions- und Vertriebs-GmbH
für Beschallungs- und Beleuchtungsanlagen

Manufacturer's Address:

Fischpicke 5, D-57482 Wenden, Germany

Declares that the product with the model name:

CAMCO Power amplifier **Q - POWER 4**, **Q - POWER 6** and **Q - POWER 10**

Conforms to the following standards:

- EN60065 Safety
- EN55103-1 Emission
- EN55103-2 Immunity

The operating conditions and application environments presupposed in the information for use (user manual) are to be kept accordingly.

Wenden, 15.12.2007

Joachim Stöcker



P.2	IMPORTANT SAFETY INSTRUCTIONS	
P.3	EXPLANATION OF SYMBOLS / SAFETY	
P.5	EC DECLARATION OF CONFORMITY	
P.6	CONTENTS	
P.7	1 WELCOME	
	1.1 Welcome to CAMCO	
	1.2 Unpacking	
P.8	1.3 The Amplifier	
	2 FACILITIES	
	2.1 <i>Q-POWER</i> – The Front	
P.9	2.2 <i>Q-POWER</i> – The Rear	
P.10	2.3 Factory Settings	
P.11	3 INSTALLATION	
	3.1 Mains Supply	
	3.2 On/Off Switch	
P.12	3.3 Mounting	
P.13	3.4 Cooling	
	3.5 Wiring	
	3.5.1 Input Connectors	
	3.5.2 Output Connectors	
P.15	4 OPERATION	
	4.1 Indicators	
	4.1.1 On LEDs	
	4.1.2 Signal / Protect LEDs (multifunctional)	
	4.1.3 I-Out LEDs	
	4.1.4 Clip LEDs	
P.16	4.2 Controls	
	4.2.1 Volume Control	
	4.2.2 Gain selector	
	4.2.3 Limiter Switch	
	4.3 Power Amp Protection Systems	
	4.3.1 Clip Limiter	
	4.3.2 SOA Protection	
	4.3.3 DC Protection	
	4.3.4 DC Servo	
	4.3.5 Over Current Protection	
	4.3.6 Thermal Protection	
P.17	4.4 Mains Protections	
	4.4.1 Inrush Current Limitation	
	4.4.2 Mains Over Voltage Detection	
	4.4.3 Mains Failure Detection	
	4.4.4 Fuse Protection	
	4.5 Main SMPS Protections	
	4.5.1 Over Current Protection	
	4.5.2 Thermal Protection	
	4.6 Fans	
P.18	4.7 Filter Cleaning	
P.19	4.8 Mounting the Volume Control Security Cover	
P.20	5 TROUBLESHOOTING	
	5.1 Problem: No Sound	
	5.2 Problem: Distorted Sound	
	5.3 Problem: Hiss	
	5.4 Problem: Squeals and Feedback	
P.22	6 SPECIFICATIONS	
P.24	7 MEASUREMENTS	
P.27	8 WARRANTY INFORMATION	
	8.1 Summary Of Warranty	
	8.2 Items Excluded From This Warranty	
	8.3 What CAMCO Will Do	
	8.4 How To Obtain Warranty Service	
	8.5 CAMCO's Product Improvement	
P.28	9 SERVICE INFORMATION	
P.29	10 MAINTENANCE INFORMATION / 11 DECOMMISSIONING	
P.30	COMPANY INFORMATION	



1.1 Welcome to CAMCO

Established in 1983, **CAMCO** has gained worldwide experience with professional sound reinforcement technology. Within the audio market **CAMCO** specialises in the production and marketing of high quality power amplifiers and sound systems for use both on tour and in fixed installations.

The success of the **LA, DL, DX, VORTEX** and **TECTON** series of power amps has made the **CAMCO** name synonymous with professional quality, high performance and utterly reliable power amps.

CAMCO's commitment to research and development, seen not just in the area of materials and technology but also most importantly in its highly skilled and motivated workforce, is one of the keys to its ongoing success.

With its all-new **Q-POWER** amp series, **CAMCO** is pioneering a new dimension in professional power amp construction. The seamless combination of groundbreaking technology with proven safety elements is the hallmark of the new series.

Welcome to the new world of professional power amplifiers –

WELCOME TO CAMCO!

1.2 Unpacking

Please unpack and inspect your new amplifier for any damage that may have occurred during transit. If damage is found, notify the transportation company immediately. Only you the consignee may initiate a claim for shipping damage. **CAMCO** will be happy to cooperate fully as needed. Please save the shipping carton as evidence of damage for the shipper's inspection.

Even if the amplifier has arrived in perfect condition, save all packing materials so you will have them if you ever need to transport the unit.

NEVER SHIP THE AMPLIFIER WITHOUT THE ORIGINAL PACKING MATERIALS.

When shipping the **Q-POWER** amplifier, always use the original shipping carton and packing materials. For maximum protection, repack the unit as it was originally packed at the factory.

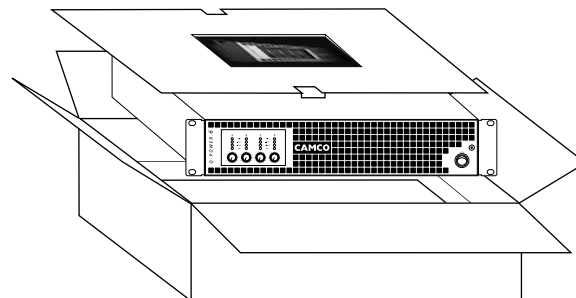

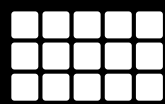

1.3 The Amplifier

The **Q-POWER**-series amplifiers offer a power output of:

- Q-POWER 4** 1 kW peak per channel @ 4 Ω, using a Bipolar class H (2-step) high efficiency power amplifier output stage
- Q-POWER 6** 1,5 kW peak per channel @ 4 Ω, using a Bipolar class H (2-step) high efficiency power amplifier output stage
- Q-POWER 10** 2,5 kW peak per channel @ 4 Ω, using a MOSFET class D high efficiency power amplifier output stage

The **Q-POWER**-series amplifiers are fitted with dual voltage Switched Mode Power Supplies (SMPS), which significantly reduce the weight and size (only 2U) of the amplifiers. Using SMPS, the symmetrical supply voltages of the power amplifier are more stable than the power supplies used in conventional amplifiers.

The dual-voltage feature of the **Q-POWER** amplifiers senses the mains before startup and automatically sets the SMPS to the appropriate voltage (120 V or 230 V). No manual voltage setting will be necessary.

2 Facilities

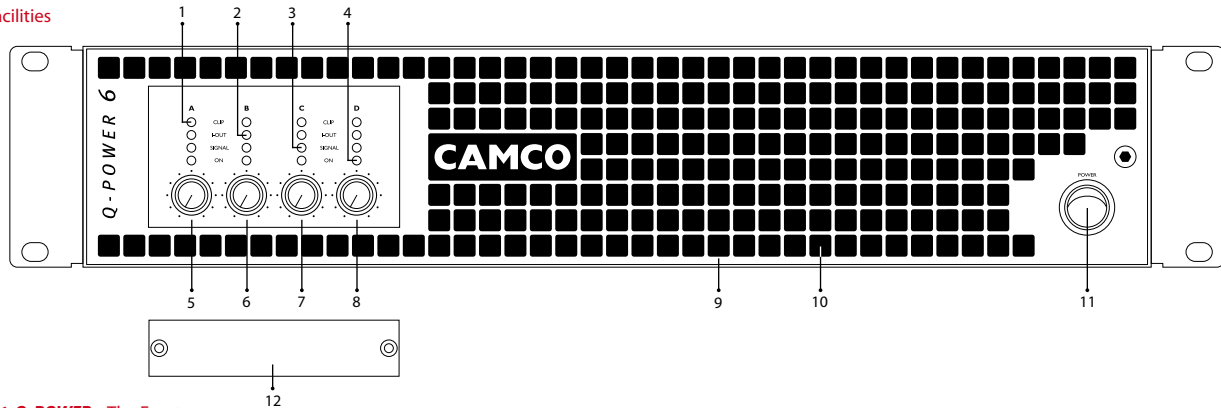

2.1 Q-POWER – The Front

- | | | |
|---------------|----------------------------|--|
| 1 Clip LEDs | 5 Volume Control Channel A | 9 Removable Air Filter System |
| 2 I-Out LEDs | 6 Volume Control Channel B | 10 Cooling Air Inlet Vents |
| 3 Signal LEDs | 7 Volume Control Channel C | 11 On/Off Switch |
| 4 On LEDs | 8 Volume Control Channel D | 12 Optional Volume Control Security Cover (included) |

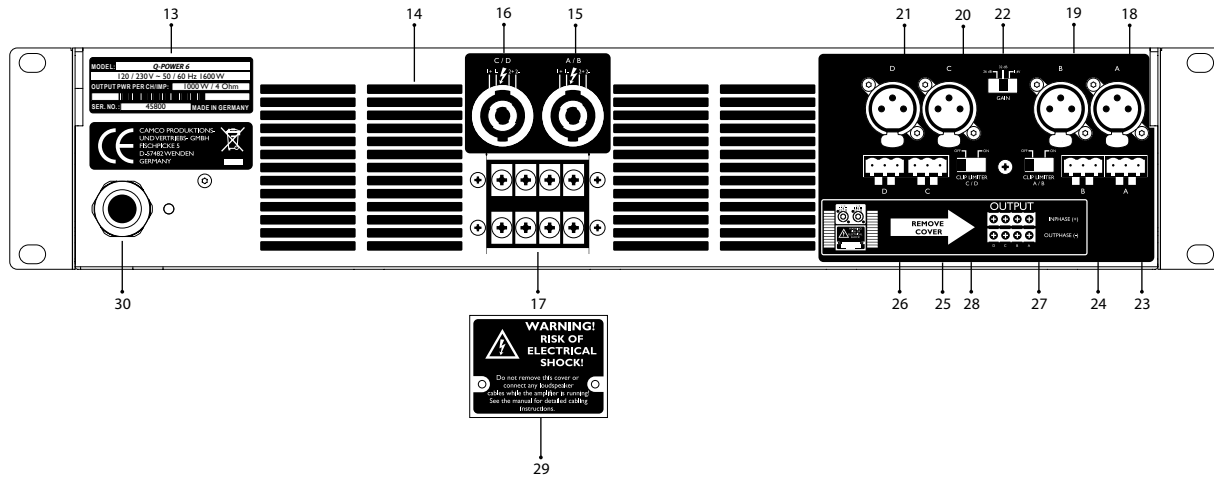
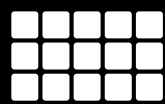

2.2 Q-POWER – The Rear

13 Rating Plate

14 Cooling Air Outlet Vents

15 SPEAKON Outlet Channel A/B

16 SPEAKON Outlet Channel C/D

17 Barrier Strip Outlets Channel A B C D

18 XLR Input Channel A

19 XLR Input Channel B

20 XLR Input Channel C

21 XLR Input Channel D

22 Gain Selector

23 Euroblock Input Channel A

24 Euroblock Input Channel B

25 Euroblock Input Channel C

26 Euroblock Input Channel D

27 Clip Limiter Switch Channel A/B

28 Clip Limiter Switch Channel C/D

29 Barrier Strip Security Cover

30 AC Power Cable

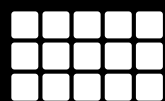

2.3 Factory settings

Q-POWER amplifiers are delivered with the following factory settings:

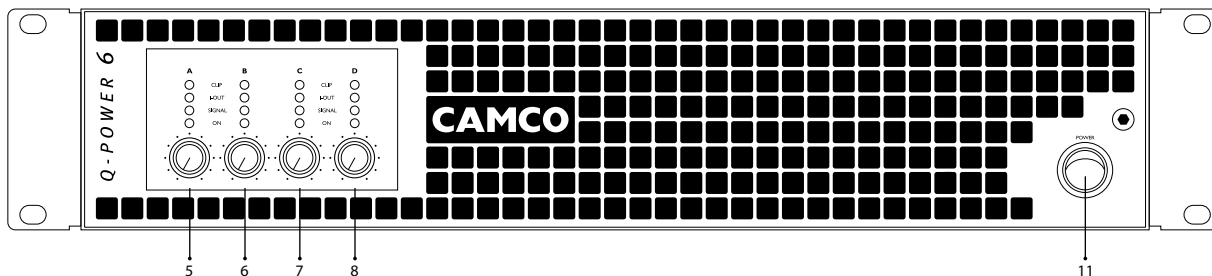

Front panel:

- 11 On/Off Switch The amplifier is switched off.
- 5 - 8 Volume Control The volume is set to minimum.

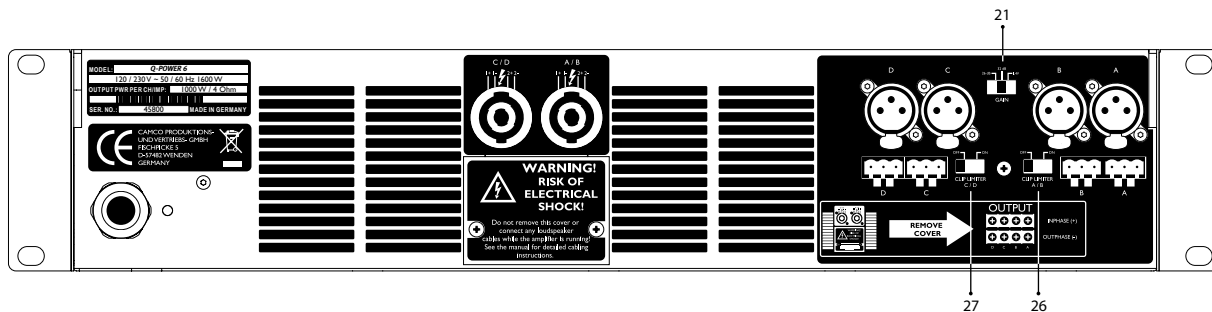

Rear panel

- 21 Gain Selector 32 dB
- 26 Clip Limiter Switch Channel A/B Off
- 27 Clip Limiter Switch Channel C/D Off

Make sure that the switches are set to the configuration needed for each particular application.

3.1 Mains supply

When mounting or connecting the amplifier always disconnect it from mains. Only connect the Q-POWER amplifier to an appropriate AC circuit and outlet, according to the requirements indicated in the second line on the rating plate.

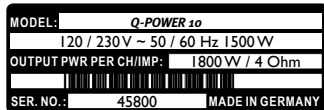
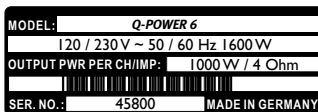
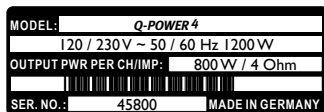

Exemplary rating plates for a mains supply of 120 / 230 V ~ 50 / 60 Hz.

Power Supply Data:

	Voltage	Frequency	Current	Power Consumption
Q-POWER 4	120 / 230 V ~	50 / 60 Hz	15 / 8,5 A	1200 W
Q-POWER 6	120 / 230 V ~	50 / 60 Hz	22 / 12 A	1600 W
Q-POWER 10	120 / 230 V ~	50 / 60 Hz	21 / 11 A	1500 W

NOTE: Only fixed 120 V or 230 V operation is possible. The amplifier should not be permanently operated at voltages not within the specified range (rated voltage $\pm 10\%$), as this might affect the overall performance.

NOTE: The rated power consumption and mains current draw is measured at 1/8 of the rated output power (i.e. 4 x 100 W for the Q-POWER 4, 4 x 125 W for the Q-POWER 6 and 4 x 225 W for the Q-POWER 10) with pink noise to represent typical music signal. The mains current and power consumption can be considerably higher (or lower) depending on the effective output power.

3.2 On/Off switch

The On/Off switch is a rocker-type switch. It is located on the right side of the front panel. To turn the amplifier on, push in on the upper part of the switch. This initiates start-up by activating the inrush current limiter. During power up the clip and signal LEDs will light up in red for a few seconds. To turn the amplifier off, push in on the lower part of the switch.

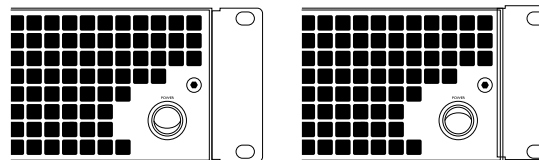

The amplifier is switched on.

The amplifier is switched off.

NOTE: This switch does NOT disconnect the amplifier from mains.

The switch initiates start-up by activating the current limiting function. As soon as the power amplifier is connected to the mains power supply, a voltage is supplied to both the line-filter and the fused input of the controllable rectifier. Disconnecting the amplifier from the main power supply can only be achieved by physically separating the amplifier from the mains by pulling the mains plug. The mains plug therefore has to be freely accessible. Disconnect the mains plug from the mains during a lightning storm or when the amplifier remains unused or un-supervised for a prolonged period of time. Alternatively, you can disconnect the amplifier via an external all-pole disconnection from the mains.

If a power cut occurs while the amplifier is switched on, it will restart automatically once the power supply has been restored. All settings prior operation to the loss of power will be maintained.

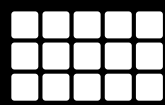

3.3 Mounting

Use four screws and washers when mounting the amplifier to the front rack rails.
For mobile use, the amplifier should also be secured using the 19" mounting elements on the rear panel.

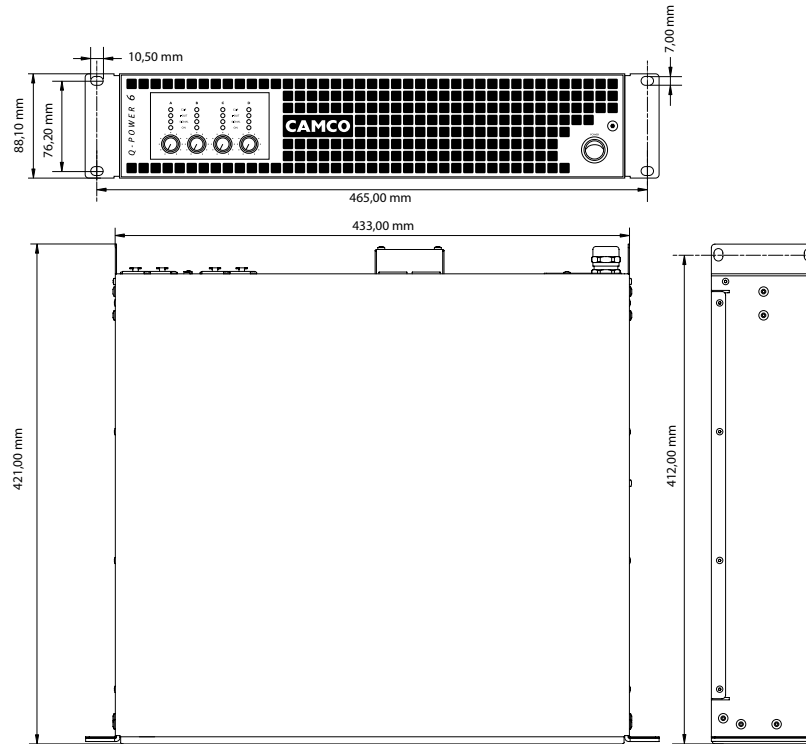

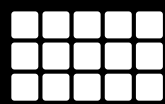

3.4 Cooling

Under normal operation of the power amp, overheating should never be a problem. The air is taken in from the front and out through the back. It is of course essential that while the power amp is running air is able to circulate around it freely.

The efficiency of the cooling will depend on the immediate environment (e. g. an enclosed rack, direct sunlight) and on whether the front filter is clogged. If the amp is installed in a case the open area at the back of the case must be at least 140 cm². This area should be in line with the amp.

If this cannot be achieved a forced ventilation system has to be used.

3.5 Wiring

3.5.1 Input Connectors

XLR: Pin 1 = Ground
Pin 2 = Hot (inphase, +)
Pin 3 = Cold (out of phase, -)

Euroblock connector: Pin 1 = Hot (inphase, +)
Pin 2 = Ground
Pin 3 = Cold (out of phase, -)

Make sure to always use high-quality symmetrical (balanced) shielded cable to ensure maximum audio quality.

Please do not simultaneously attach two independent signal sources to the XLR and Euroblock input connectors of the same channel. This could lead to volume and audio quality loss and could damage the connected signal sources.

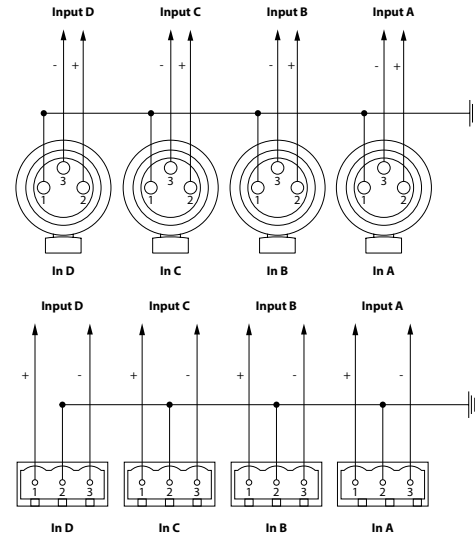

3.5.2 Output Connectors

The two SPEAKON connectors are connected to the channel A to D power amplifier outputs. The pin configuration of the SPEAKON-connectors is as follows:

- | | | |
|------------|--------|--------------------|
| Top Right: | Pin 1+ | Channel A signal + |
| | Pin 1- | Channel A signal - |
| | Pin 2+ | Channel B signal + |
| | Pin 2- | Channel B signal - |
| Top Left: | Pin 1+ | Channel C signal + |
| | Pin 1- | Channel C signal - |
| | Pin 2+ | Channel D signal + |
| | Pin 2- | Channel D signal - |

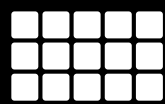

The pin configuration of the Barrier Strip connector is as follows:

Top row from left to right:

(all signal +) Channel D - Channel C - Channel B - Channel A

Bottom row from left to right:

(all signal -) Channel D - Channel C - Channel B - Channel A

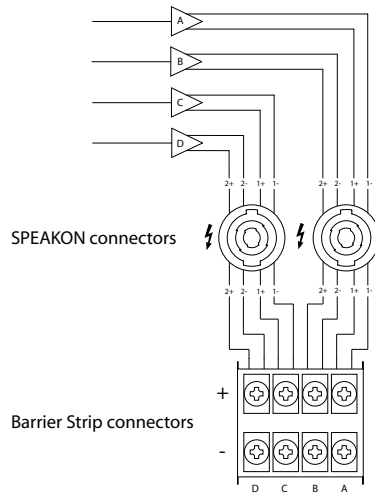

The **Q-POWER 6** and **Q-POWER 10** amplifiers are optimised for a loudspeaker impedance of 4Ω . Especially the **Q-POWER 4** can handle impedances down to 2Ω . Attaching lower impedances might affect audio quality and overall performance of the amplifier.

NOTE / IMPORTANT:

The **Q-POWER 10** uses a bridged power amplifier output stage. This implies that the signal - loudspeaker outputs are not (and must never be) directly connected to the electrical ground (earth) or chassis of the amplifier! Please make sure to always attach the loudspeakers only between the signal + and the signal - outputs of the same channel on the SPEAKON or Barrier Strip connectors.

Wiring to the output connectors must conform to NEC Class 2 safety standards or its equivalent that meets all national and local electric codes.

For reasons of safety and performance, only use high-quality fully insulated speaker cables of stranded copper wire. Use the largest wire size that is economically and physically practical and make sure that the cables are no longer than necessary.

WARNING!

The lightning flashes near the output connectors indicate high voltages that are potentially life threatening.

Wiring to these terminals requires installation by an instructed person or the use of ready-made leads or cords. Custom wiring should only be carried out by qualified personnel.

To prevent electric shock, do not operate the amplifier with any of the conductor portion of the speaker wire exposed.

To connect any custom speaker cable wiring to the Barrier Strip connectors remove the security cover which is held by two screws. Take care to **reinstall the security cover after all connections are made**, and be cautious to avoid short-circuits between the speaker wires and the security cover or chassis (for example due to damaged or clamped cable isolations).

NOTE: Any damage to the loudspeaker or amplifier due to wrong cabling will not be covered by warranty.

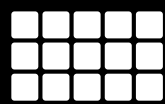

4.1 Indicators

4.1.1 On LEDs

Under normal operation, after the amp has started, the green power LEDs are permanently lit.

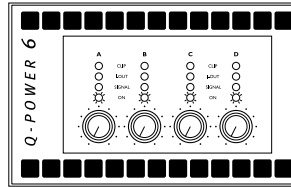

4.1.2 Signal / Protect LEDs (multifunctional)

The green Signal LEDs are illuminated when the voltage level at the output reaches approx. 4 V; this corresponds to a power of approx. 4 W into a 4 Ohm load. The channel signal LEDs are illuminated red when the amplifier is in Protect Mode (Mute), for example because of persistent DC-voltage at the outputs or overheating.

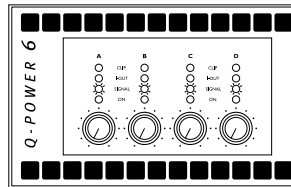

4.1.3 I-Out LEDs

The brightness is proportional to the output current in the channel.

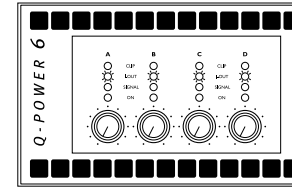

4.1.4 Clip LEDs

This LED indicates an overloading of the amplifier when the power output level is too high.

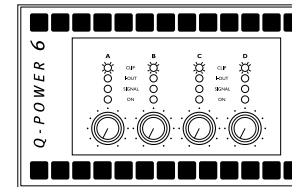



4.2 Controls

4.2.1 Volume Control

A volume control with 41 notched settings controls the audio signal. These settings have been selected to correspond to human hearing characteristics (logarithmically) and therefore guarantee an optimal range of settings for practical applications. Each channel can be set individually.

Set the volume to zero before turning on the amplifier to prevent the occurrence of sudden high volume levels which may cause damage to your hearing and/or the speakers.

4.2.2 Gain Selector

A switch on the rear of the **Q-POWER** amplifiers allows the maximum amplification attainable to be set directly in the input stage.

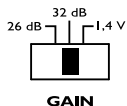

The **Q-POWER** amplifiers have a 26 dB and 32 dB voltage gain setting along with a 1,4V sensitivity setting.

4.2.3 Limiter Switch

This switch is located at the rear of **Q-POWER** amplifiers. It allows you to activate the clip limiter function on the channels A/B and C/D respectively.

4.3 Power Amp Protection Systems

4.3.1 Clip Limiter

If the power amp is overdriven and the limiter is set to on (see section 4.2.3) the clip detection triggers the Attack-Release-Circuit (ARC). The ARC delivers the control voltage for the gain reduction.

4.3.2 SOA Protection

Whenever the power transistors leave their Safe Operation Area (SOA), the SOA-protection will either switch back the current rail of the respective channel (**Q-POWER 4** & **Q-POWER 6**) or limit the maximum load current in the power transistors (**Q-POWER 10**).

4.3.3 DC Protection

Each output of the power amp is constantly monitored for persistent DC voltage levels. If the 3 V thresholds are exceeded at any of the outputs, the corresponding channel will be muted. If DC was only applied for a short moment, the amplifier will release mute and work as normal. If DC is applied for longer periods or several short times the amplifier will switch to standby mode. Switch off the amplifier, wait until all indicator LEDs extinguish and switch the amplifier on again.

4.3.4 DC Servo

To prevent DC Offset at the speaker output the **Q-POWER** amplifiers are fitted with a DC Servo.

4.3.5 Over Current Protection

Over current is permanently controlled in the output stage. In case of excessive loading the maximum output current of the amplifiers is automatically limited. This improves reliability without degrading sound quality when driving complex loads.

4.3.6 Thermal Protection

There are sensors in each amplifier heatsink in order to ascertain temperature data. If a temperature of more than 85 °C is detected at the heat sinks, the input signal on that channel is reduced proportionally to prevent further heating of the amplifier. If the temperature exceeds approximately 100 °C, the main SMPS is switched off (safety shut-off).



4.4 Mains Protections

4.4.1 Inrush Current Limitation

Within approximately 2 seconds of the **Q-POWER** Amplifier being switched on, the inrush current limiter will increase mains current smoothly from nearly zero to nominal value. This value depends on program material, output level and speaker loads.

4.4.2 Mains Over Voltage Detection

Mains Over Voltage Detection is always operative. When the mains voltage exceeds approx. 263 V (230 V operation) or 137 V (120 V operation), the amplifier will switch off. When the mains voltage returns to nominal value a soft start occurs.

4.4.3 Mains Failure Detection

Mains Failure Detection is always operative. When the mains supply is interrupted for about 2 mains cycles, the amplifier will switch off. When the mains voltage returns to a normal value a soft start occurs.

4.4.4 Fuse Protection

The fuse protection circuit prevents amplifier shut-down (e.g. by a blown mains fuse or a triggered circuit breaker) during extremely hard use with all channels working at very high output power. Without intelligent mains current monitoring and control this could easily happen as the rated output power is several times higher than the capabilities of the standard mains supply.

In order to prevent any shutdown in extreme situations the amplitude of the input signals will be reduced which will in return also reduce the mains current draw.

4.5 Main SMPS Protections

4.5.1 Over Current Protection

The main SMPS (Switched Mode Power Supply) transformer current of your **Q-POWER** Amplifier is continuously monitored. If over current occurs the main SMPS immediately stops working. Should there be an internal failure this feature prevents other parts from being damaged.

4.5.2 Thermal Protection

If the temperature of the main SMPS transformer exceeds 90 °C, the main SMPS is switched off (safety shut-off).

4.6 Fans

The fans mounted in your **Q-POWER** Amplifier operate permanently, but as long as the temperature remains below 40 °C, they run at their slowest speed and can hardly be heard. The highest detected temperature from any amplifier channel controls the speed of the fans. Above 40 °C the speed is increased until it reaches its maximum value.



4.7 Filter Cleaning

The air intake on the front of your **Q-POWER** Amplifier is fitted with a removable filter system. If the filter becomes clogged, the unit will not cool as efficiently as it should and may result in reduced output levels.

WARNING: Turn off the amplifier before removing the front frame.

To clean or replace the filter just slightly unscrew the fixing screw (3) without completely removing it from the front frame (it is held back by a small plastic spacer on the back side of the frame to avoid loosing the screw). Then shift the front frame slightly to the right. Then you should be able to remove the frame from the amplifier completely (pull gently to avoid any bending of the front frame).

Q-POWER Filter Assembly

- 1 Foam Filter
- 2 Front Frame
- 3 Screw

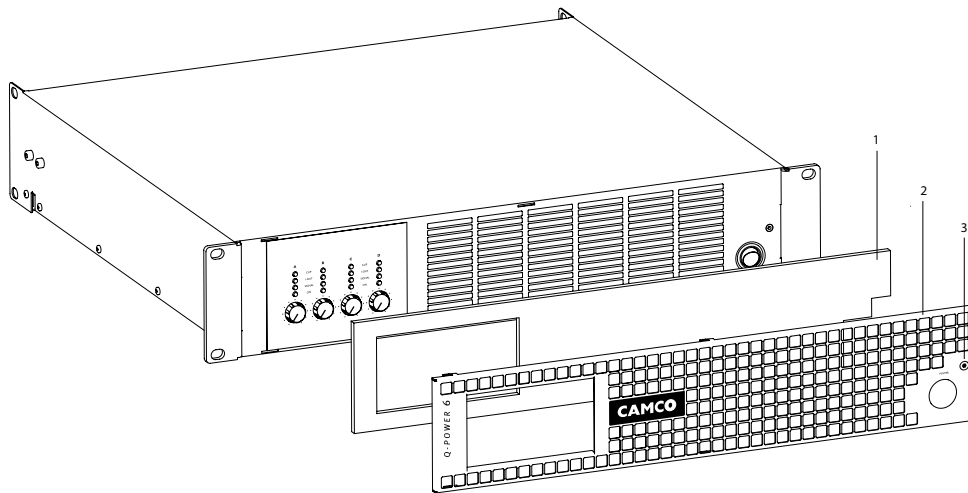



4.8 Mounting the Volume Control Security Cover

It is possible to install a solid protection over the volume controls to prevent intentional or unintentional changes of the amplifier volume settings.

WARNING: Disconnect the amplifier from the mains before installing the cover.

In the original state the holes needed to fix the security cover on both sides of the volume knobs are hidden behind the plastic front label. In case you wish to install the cover please first pierce two holes in the front label to facilitate the screwing, as shown in the drawings.

To find the exact positions of the holes take the included cardboard template you will find attached to the last page of this manual and place it on top of the volume knobs. The positions of the hidden screw holes are indicated on the template. Then firmly pierce and turn with a pointed tool (we recommend a Philips PH1 recessed head screwdriver) through the cardboard and the label at these positions to obtain a clean hole. You now should see the metal of the fine pitch thread behind the label.

Then remove the cardboard template and fix the cover with the two included M3 recessed threaded screws.

WARNING: Do not use any pointed tools (e.g. screwdriver) with a diameter of less than 3,5 mm (0,138 in), as they might be stuck too deeply inside the screw holes and damage internal components.

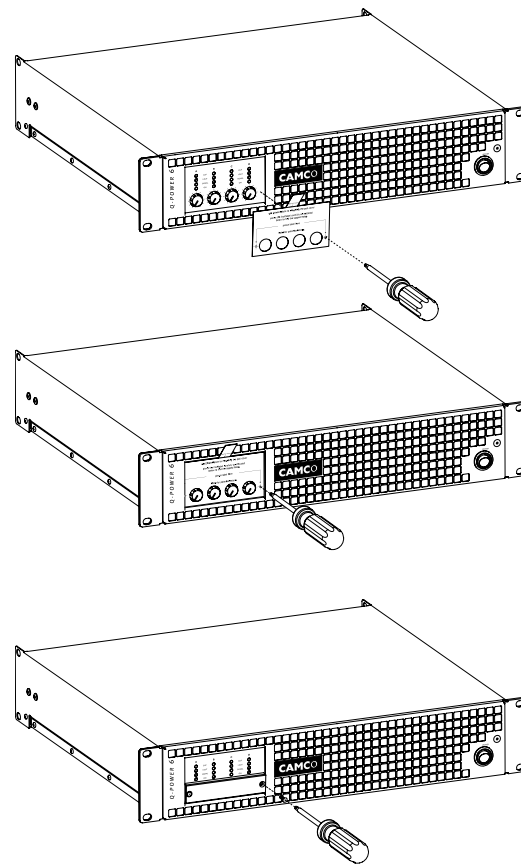



5.1 Problem: No Sound

Indication:

On LEDs not lit

Signal LEDs not lit

- Check AC plug.
- Confirm that AC outlet works by plugging in another device.

Indication:

On LEDs lit

Signal LEDs not lit

Clip LEDs not lit

- Make sure the signal source is operating and eventually try another cable.
- Check the position of the volume pots and the position of the gain selector

Indication:

Signal LEDs responding to signal level

Output Current LEDs are not lit

- Check the speaker wiring for breaks.
- Try another speaker and cable.

Indication:

Signal LEDs show red (Protect Mode)

- Overheating will cause protective muting. Check for proper ventilation. If the fans are not running the amplifier requires servicing.
- Persistent DC at the outputs will force the amplifier in protect mode and shut down the power supply.
- Try to mute or disconnect the signal source and restart the amplifier (i. e. switch off the amplifier, wait until all indicator LEDs extinguish and switch the amplifier on again).

NOTE: For other LED indications than described above or if the problem persists please unplug the amplifier from the mains supply and refer to your authorised **CAMCO** dealer/distributor or repair workshop.

5.2 Problem: Distorted Sound

Indication:

Output Current LEDs are lit

Signal LEDs responding to signal level

Clip LEDs not lit

- A faulty speaker or a loose connection could cause this. Check the wiring and try another speaker.
- The signal source might be clipping. Keep the **Q-POWER** amplifiers volume pots at least halfway up so that the source does not have to be overdriven.
- Keep the **Q-POWER** amplifiers volume pots at least halfway up and try changing input sensitivity from 1,4 V to 32 dB or 26 dB with the gain selector on the rear.

Indication:

Output Current LEDs are lit

Signal LEDs responding to signal level

Clip LEDs lit

- The amplifier is overdriven by the signal source. Reduce the input signal level



5.3 Problem: Hiss / Noise

- Unplug the amplifier input to confirm that the hiss is coming from the source or from a device upstream. Erratic or popping noises indicate an electronic fault in the offending unit.
- To keep the noise floor low, operate the primary signal source at full level without clipping.
- Avoid boosting the signal further between the source and the amplifier.

5.4 Problem: Squeals and Feedback

- Microphone feedback should be eliminated with mixer controls. If noise continues to build up with no microphone gain, there is a serious fault in the signal processors or cables. Working in succession from the signal source towards the amplifier and check each device in the signal path by reducing its gain or by unplugging it.



6 SPECIFICATIONS

	Q-POWER 4	Q-POWER 6	Q-POWER 10
Output Power 1 kHz, THD < 1 %, all channels driven	290 W @ 16 Ω 520 W @ 8 Ω 800 W @ 4 Ω 800 W @ 2 Ω	470 W @ 16 Ω 800 W @ 8 Ω 1000 W @ 4 Ω	620 W @ 16 Ω 1100 W @ 8 Ω 1800 W @ 4 Ω
	1000 W peak @ 4 Ω	1500 W peak @ 4 Ω 950 W @ 70-V line	2500 W peak @ 4 Ω 1600 W @ 70 V line 625 W @ 100 V line
1 kHz, THD < 1 %, one channel driven	300 W @ 16 Ω 580 W @ 8 Ω 1100 W @ 4 Ω 1000 W @ 2 Ω	480 W @ 16 Ω 960 W @ 8 Ω 1500 W @ 4 Ω	620 W @ 16 Ω 1350 W @ 8 Ω 2400 W @ 4 Ω
	1200 W peak @ 4 Ω	1600 W peak @ 4 Ω	2600 W peak @ 4 Ω
Circuitry	Bipolar, Class H 2-step high efficiency circuit	Bipolar, Class H 2-step high efficiency circuit	MOSFET, Class D high efficiency circuit
Signal to Noise-Ratio 20 Hz - 20 kHz, 8 Ω load, unweighted A-weighted	>110 dB >113 dB	>112 dB >115 dB	>112 dB >115 dB
Frequency Range 8 Ω, 10 dB below rated power, all channels driven		20 Hz - 20 kHz ± 0,15 dB	



6 SPECIFICATIONS

	Q-POWER 4	Q-POWER 6	Q-POWER 10
THD+N (typical) 20 Hz - 10 kHz, 8 Ω, 11 dB below rated power	< 0,02 %	< 0,03 %	< 0,05 %
Damping Factor 8 Ω, 1 kHz and below	>350	> 350	> 600
Maximum output voltage	99 Vp / 198 Vpp	125 Vp / 250 Vpp	145 Vp / 290 Vpp
Input Impedance	15 kΩ balanced		
Voltage Gain	selectable: 26 dB, 32 dB, or 1,4 V input sensitivity		
Protection Circuits	inrush-current limitation, mains voltage monitoring, temperature monitoring of transformers and heatsinks, output DC protection, SOA protection, output over current protection, intelligent mains fuse protection,		
Limiter	two individually selectable clip limiters for channels A + B and C + D		
Fan	two temperature dependent speed-controlled axial fans		
Indicators	LEDs for on, signal/protect, output current and clip		
User Interface	four individually adjustable volume control knobs for channel A - D		
Input Connectors	3-pin XLR connector per channel 3-pin Euroblock connector per channel		
Output Connectors	two four-pole SPEAKON-connectors and barrier-strip-connector terminals for channel A - D		
Dimensions (WxHxD)	483 x 88,1 x 421 mm (19";2U)		
Net Weight	10,6 kg	10,6 kg	11,5 kg
Shipping Dimensions (WxHxD)	615 x 135 x 540 mm (0,045 m³)		
Shipping Weight	12,6 kg	12,6 kg	13,5 kg

We reserve the right to make technical alterations without prior notice.

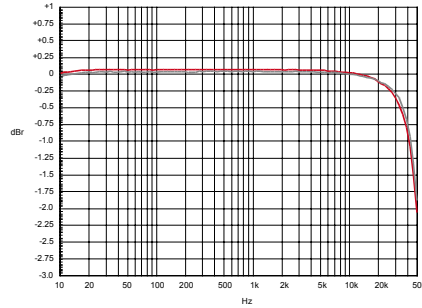
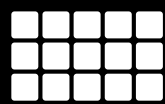

Figure 7.1
Gain vs. frequency (**Q-POWER 4/Q-POWER 6, Q-POWER 10**)
(Measurements of a typical performance)

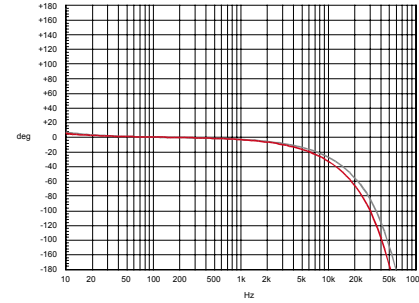

Figure 7.3
Phase vs. frequency (**Q-POWER 4/Q-POWER 6, Q-POWER 10**)
(Measurements of a typical performance)

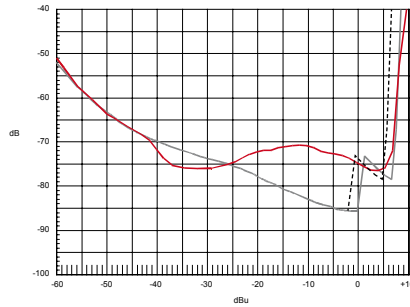

Figure 7.2
THD @ 1 kHz, 8 Ω vs. input voltage (**Q-POWER 4 / Q-POWER 6, Q-POWER 10**)
(Measurements of a typical performance)

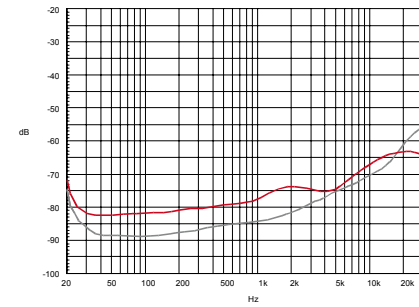

Figure 7.4
THD vs. frequency, 10 dB below clip, 8 Ω (**Q-POWER 4/Q-POWER 6, Q-POWER 10**)
(Measurements of a typical performance)

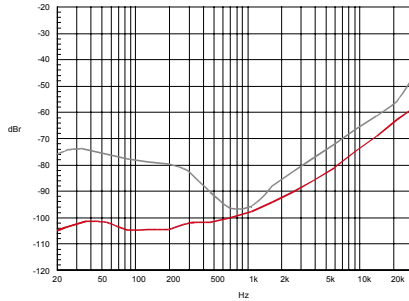
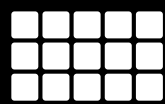

Figure 7.5

Channel separation vs. frequency @ 10 W / 4 Ω (**Q-POWER 4**/**Q-POWER 6**, **Q-POWER 10**)
(Measurements of a typical performance)

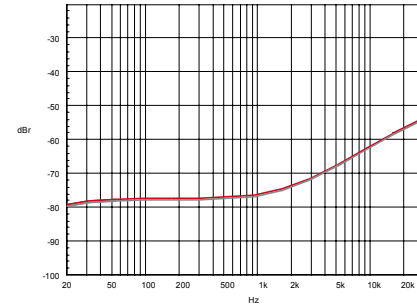

Figure 7.7

Common mode rejection ratio (**Q-POWER 4**/**Q-POWER 6**, **Q-POWER 10**)
(Measurements of a typical performance)

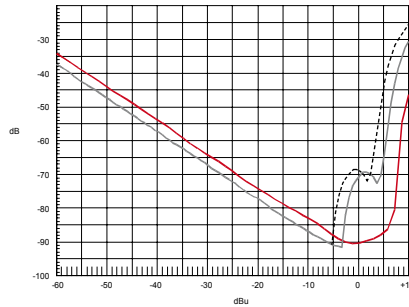

Figure 7.6

DIM intermodulation distortion @ 8 Ω vs. input level
(**Q-POWER 4** ; /**Q-POWER 6**, **Q-POWER 10**)
(Measurements of a typical performance)

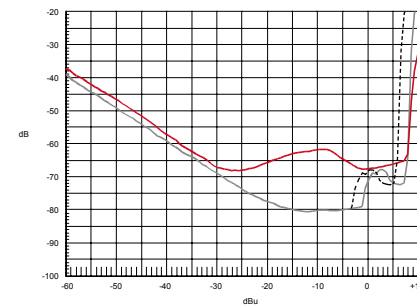

Figure 7.8

SMPTE intermodulation distortion (60 Hz and 7 kHz) @ 8 Ω vs. input level
(**Q-POWER 4** ; /**Q-POWER 6**, **Q-POWER 10**)
(Measurements of a typical performance)

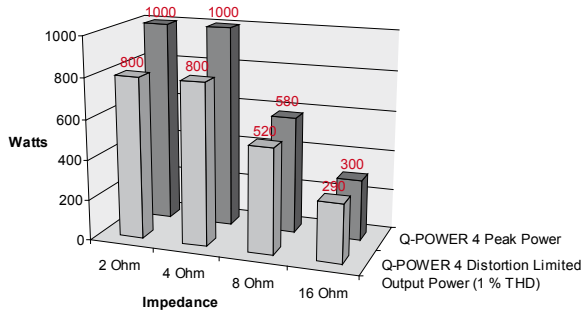
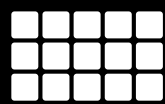

Figure 7.9

Q-POWER 4 (Measurements of a typical performance)

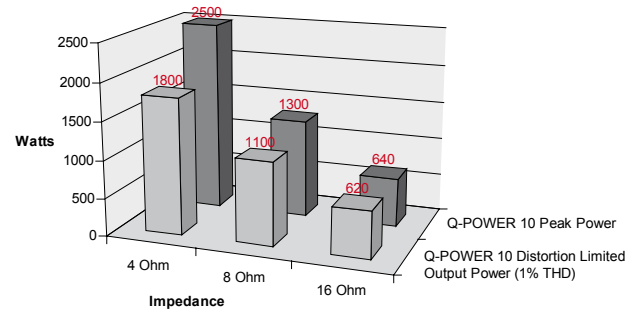

Figure 7.11

Q-POWER 10 (Measurements of a typical performance)

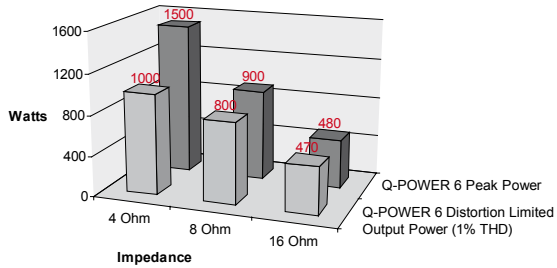

Figure 7.10

Q-POWER 6 (Measurements of a typical performance)



8.1 Summary of Warranty

CAMCO guarantees the **Q-POWER** Amplifier to be free from defective material and/or workmanship for a period of six (6) years from the date of sale. When a defect occurs under normal installation and use, **CAMCO** will repair the product under this warranty. In this event, please return the amplifier to your dealer/distributor together with a copy of your sales receipt as proof of purchase.

This warranty provides that examination of the returned product must indicate in our judgment a manufacturing defect.

8.2 Items Excluded from This Warranty

CAMCO is not liable for any damage caused by shipping accidents, misuse, abuse, operation with incorrect AC voltage, operation with faulty peripheral equipment, modification or alteration without prior factory approval, service by an unauthorised service center and normal wear and tear. Amplifiers on which the serial number has been removed or defaced are not eligible for warranty service.

8.3 What CAMCO Will Do

CAMCO (or its appointed agent) undertakes to rectify any defect regardless of the reason for failure (unless excluded from this warranty), by repair, replacement or refund as it sees fit.

8.4 How to Obtain Warranty Service

You must notify your dealer/distributor of your need for warranty service. All components must be shipped in the original packaging.

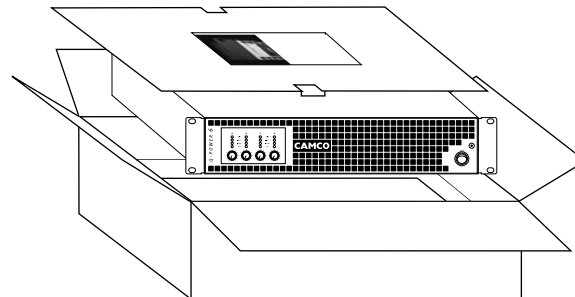

8.5 CAMCO Product Improvement

CAMCO reserves the right to improve the technical standard of its products without giving prior notice. If in any doubt, please consult your dealer/distributor or contact **CAMCO** directly for clarification.

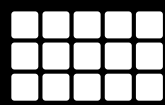

**PLEASE ENCLOSE THIS COMPLETED FORM WITH THE AMPLIFIER
DO NOT SEND SEPARATELY**

Owner's Information

Company Name: _____

Contact: _____

Address: _____

Telephone: _____

Facsimile: _____

eMail Address: _____

Model: _____

Serial Number: _____

Purchase Date: _____

Nature Of Problem

Please describe the conditions that existed when the problem occurred and what attempts were made to correct it: _____

Expired Warranty

If the warranty has expired, payment will be:

- Cash/Cheque
- VISA
- MasterCard

Other equipment in your system: _____

Shipping Address

To transport the amplifier, the original packing materials must be used. Please return the amplifier to the following address or your nearest **CAMCO** appointed distributor.

Our web site: **www.camcoaudio.com** provides a complete list of **CAMCO** dealers/distributors.

CAMCO Produktions- und Vertriebs-GmbH für Beschallungs- und Beleuchtungsanlagen, Fischpicke 5, D-57482 Wenden, Germany





10 Maintenance Information

Cleaning and servicing the inside of the amplifier must never be carried out by unqualified personnel. The amplifier must never be opened by unqualified personnel.

Cleaning and servicing work on the inside of the amplifier must only be carried out by qualified personnel.

Qualified personnel is defined as a person who has gained specialised relevant knowledge of electronic engineering through education, training and experience and who has sufficient knowledge of all relevant governmental work safety regulations to be in a position to judge the safe functioning of power amplifiers based on technical rules according to IEC 60065.

(IEC 60065 (DIN EN 60065) "Safety Requirements for Audio, Video or similar Electronic Appliances")

In order to guarantee the safe functioning of the amplifier, it has to be checked regularly depending on its application but at least once a year by a properly qualified person.

Advice on how to carry out these checks can be found in DIN VDE 0702-1 "Safety Checks for Electronic Appliances".

An amplifier that is considered to be unsafe must be labelled accordingly and stored in a safe place to prevent this amplifier being used mistakenly.

For details on removal and cleaning of the front filter refer to section 4.7.

11 Decommissioning

During the decommissioning process of the amplifier, all legally prescribed rules and procedures must be adhered to.



Mailing Address:

CAMCO Produktions- und Vertriebs-GmbH
für Beschallungs- und Beleuchtungsanlagen
Fischpicke 5
D-57482 Wenden
Germany

Telephone:

+49 (0) 2762 408-0

Facsimile:

+49 (0) 2762 408-10

Internet:

www.camcoaudio.com

Email:

postmaster@camcoaudio.com



NOTICES



JIG

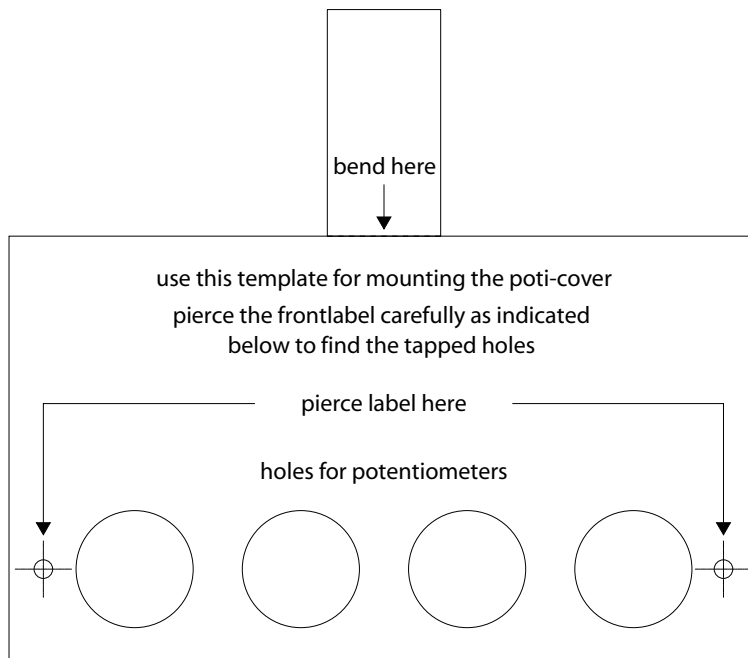

CAMCO

www.camcoaudio.com